

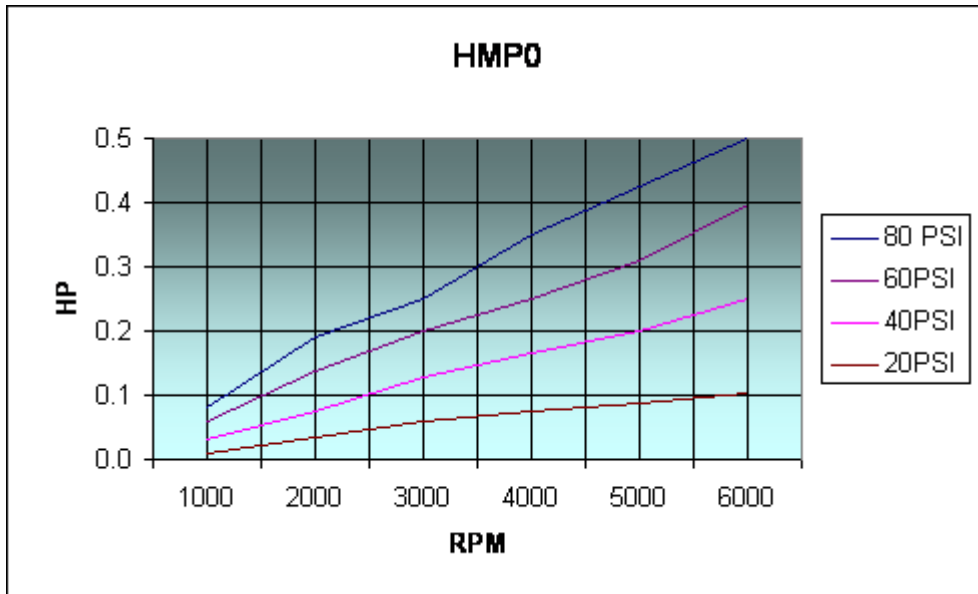

MOTOR MODELO HMP0

Rotação x potencia



Consumo de ar do motor HMP0

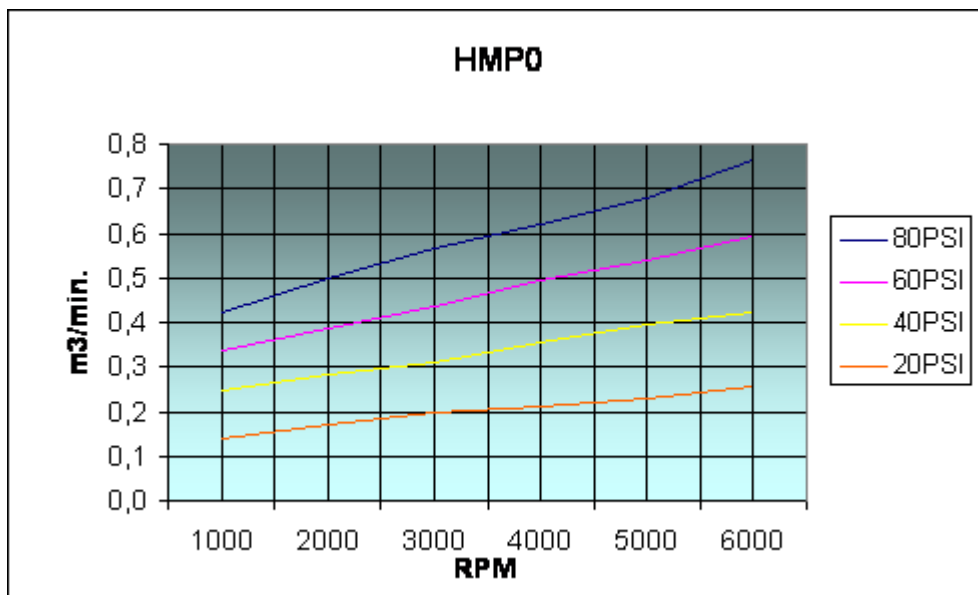



Torque do motor HMP0

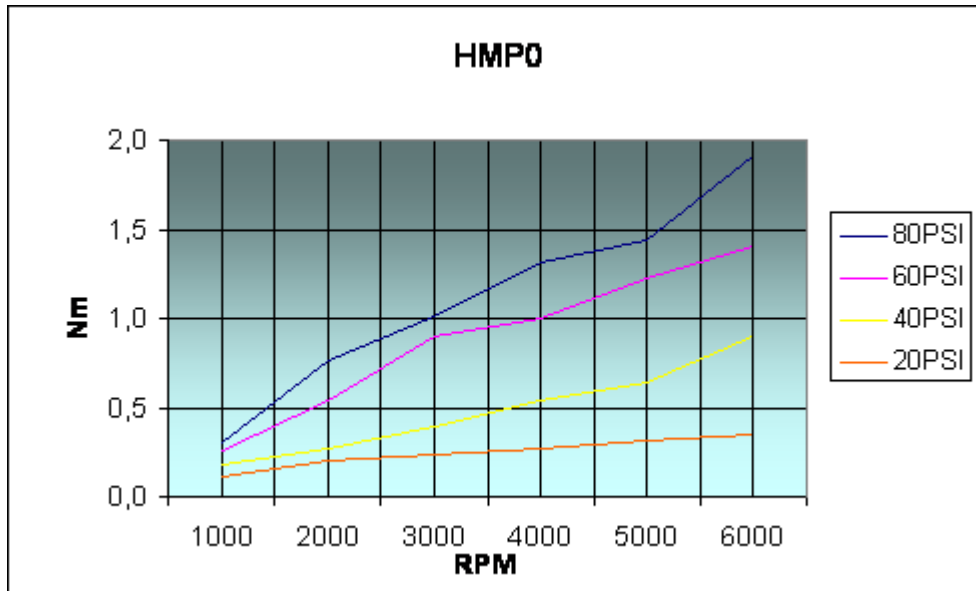

MOTOR MODELO HMP1

Rotação x potencia

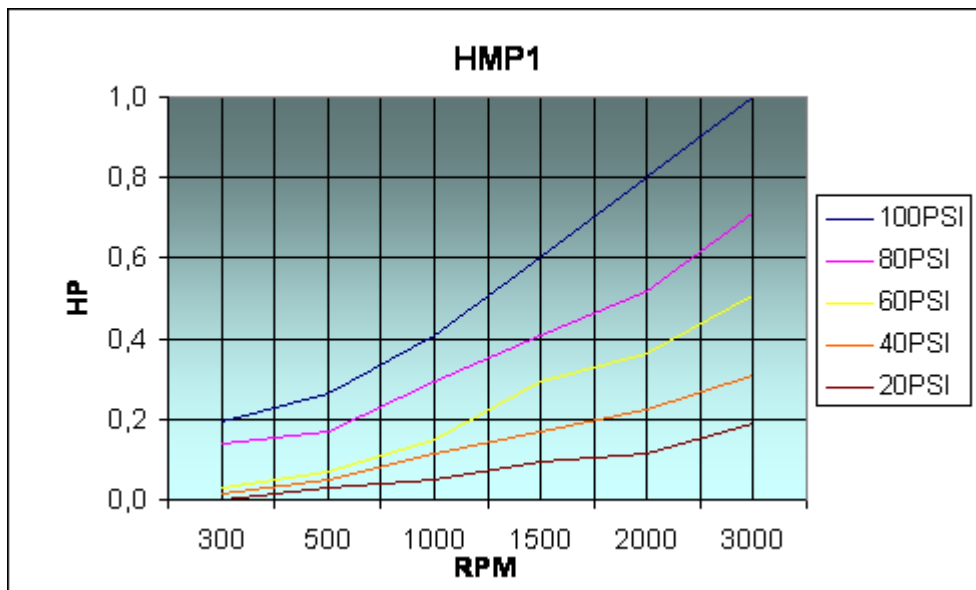



Consumo de ar do motor HMP1

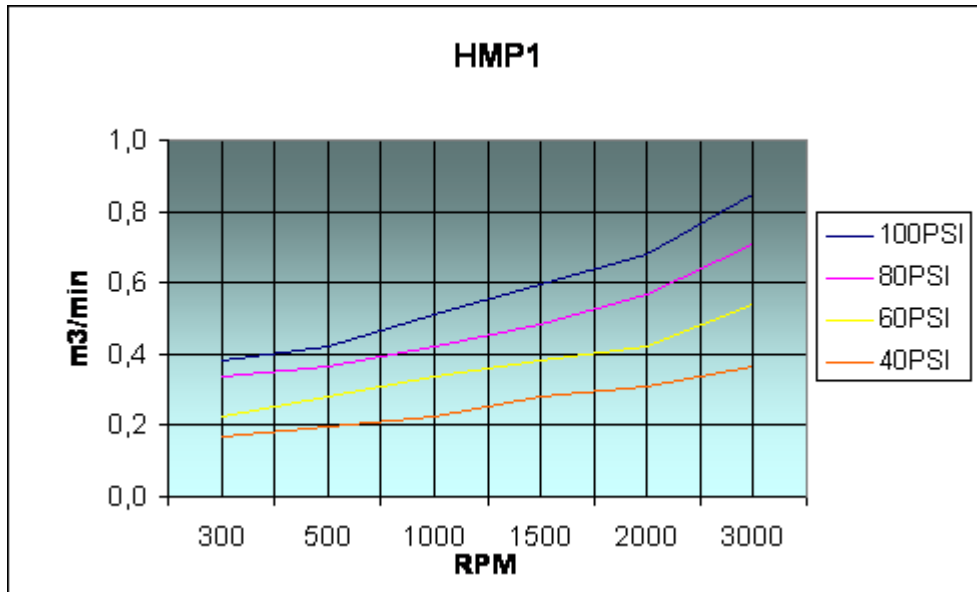

Torque do motor HMP1

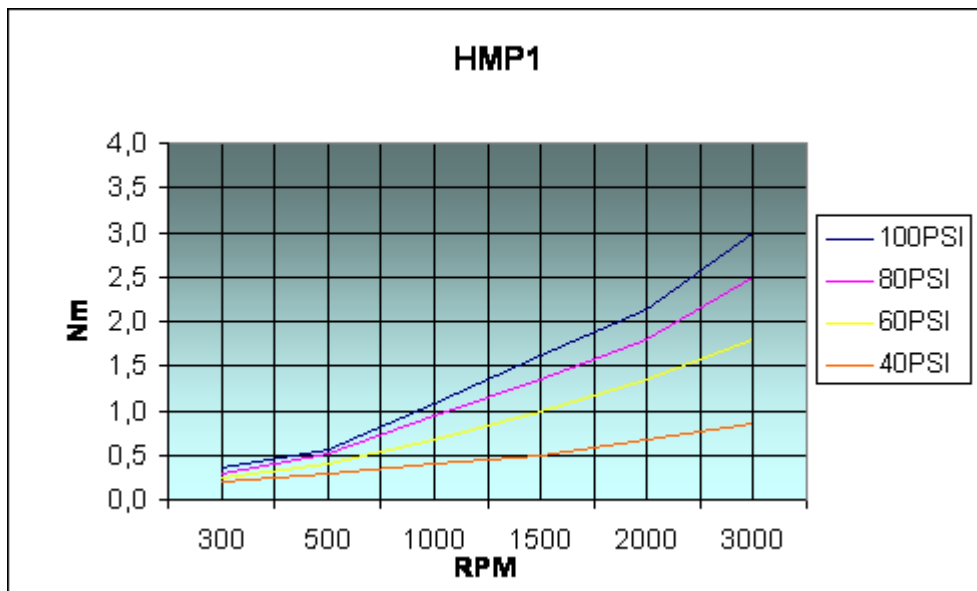



MOTOR MODELO HMP2

Rotação x Potencia

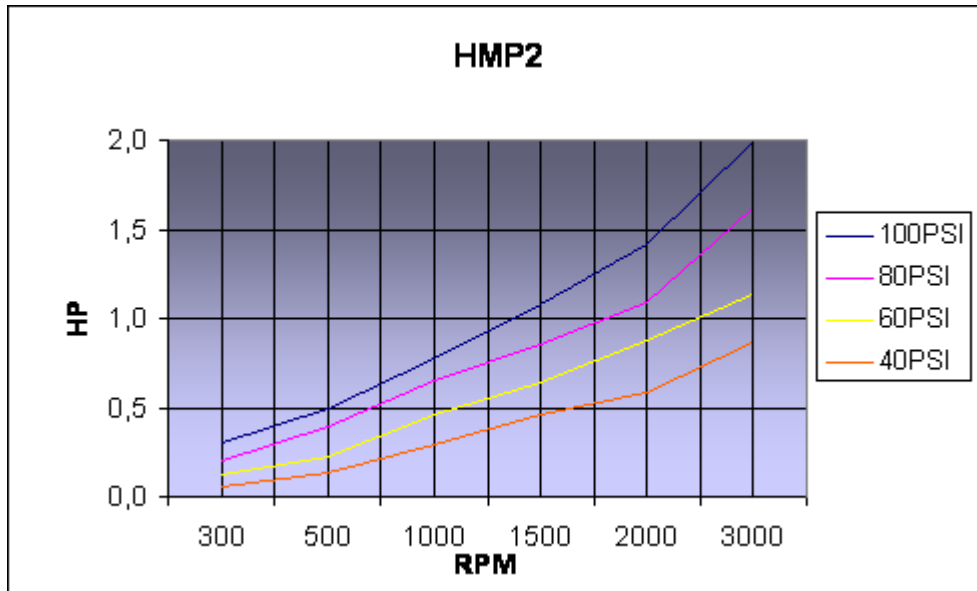

Consumo de ar do motor HMP2

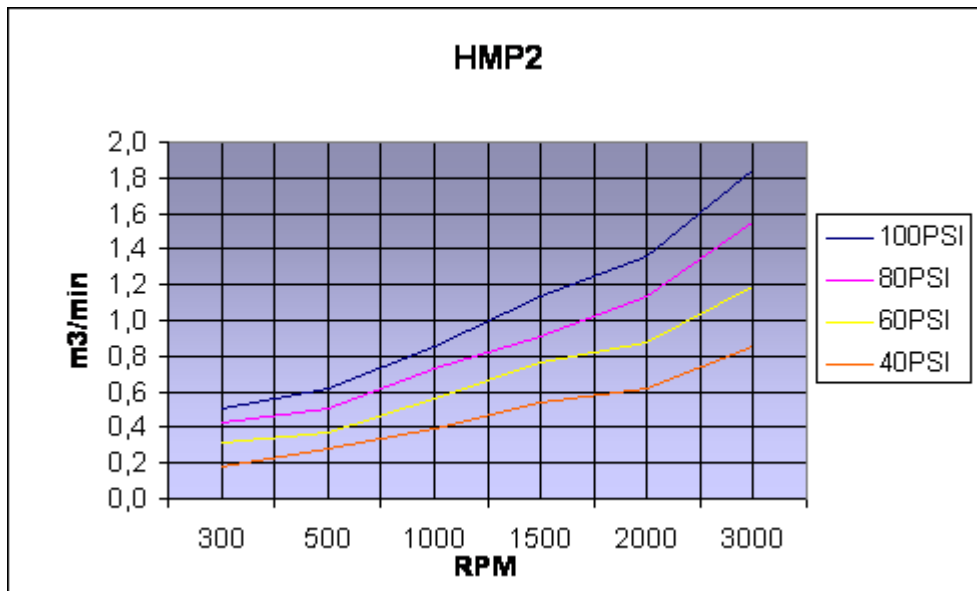



Torque do motor HMP2

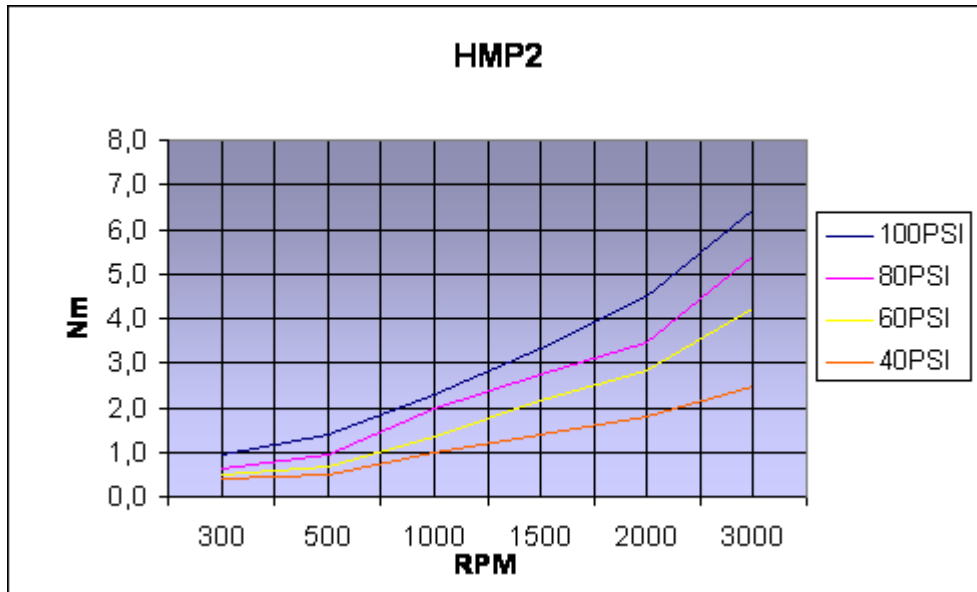

MOTOR MODELO HMP4

Rotação x Potencia

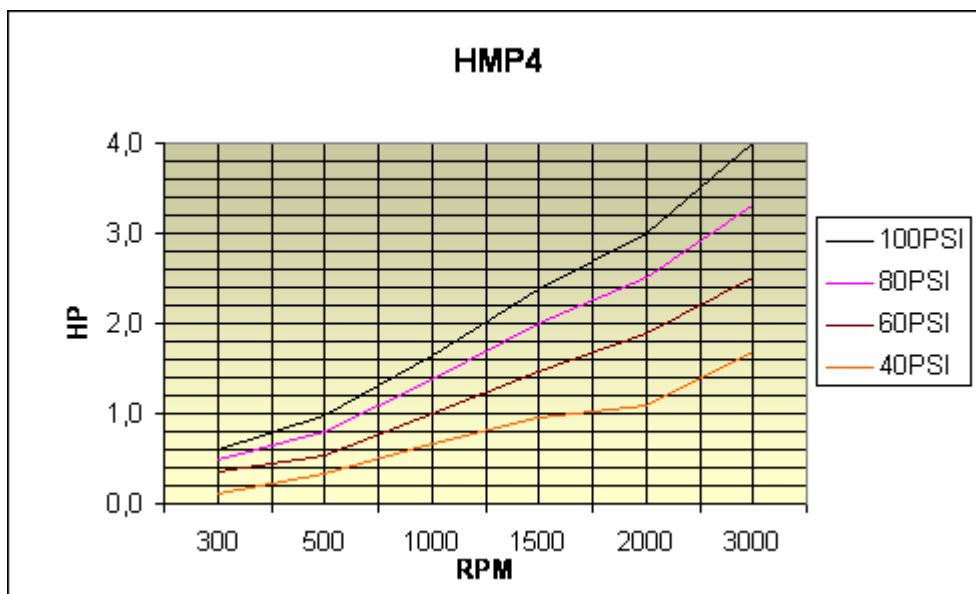



Consumo de ar do motor HMP4

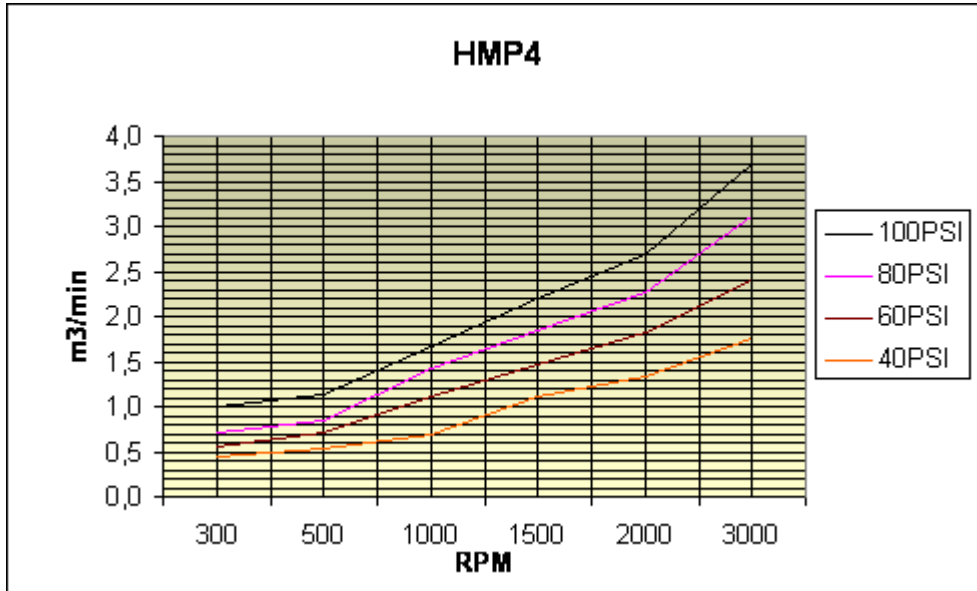

Torque do motor HMP4

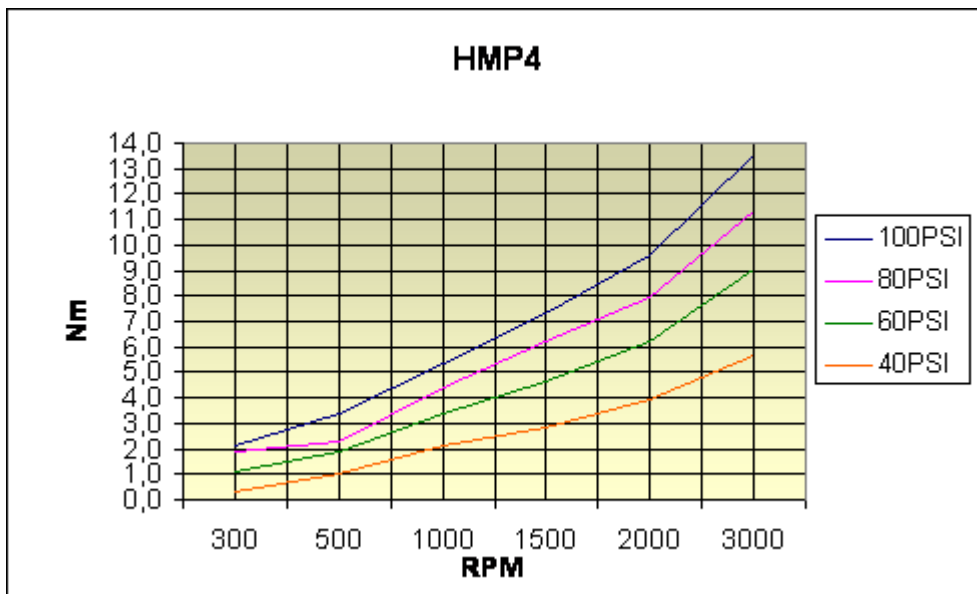



MOTOR MODELO HMP5

Rotação x Potencia

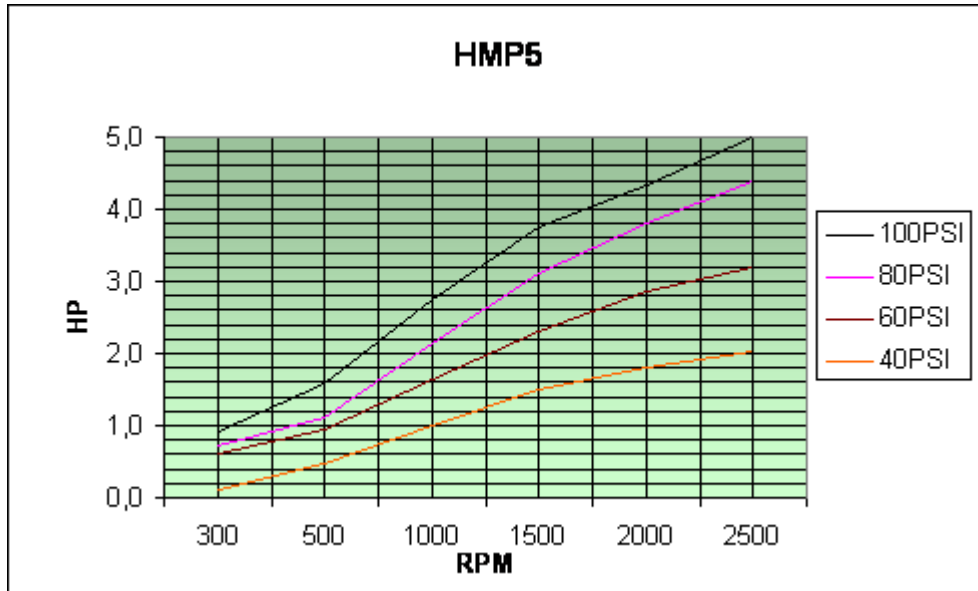

Consumo de ar do Motor HMP5

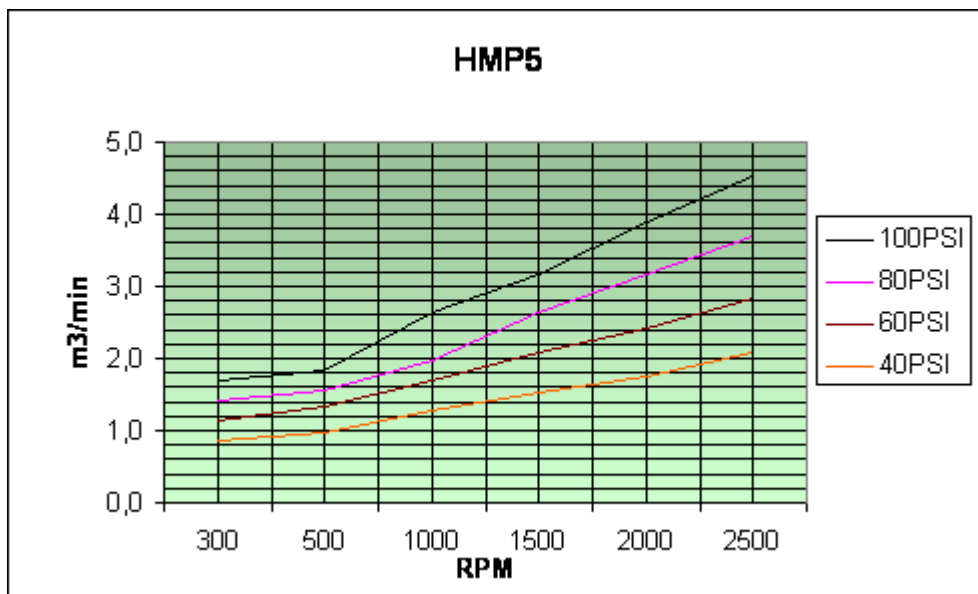



Torque do motor HMP5

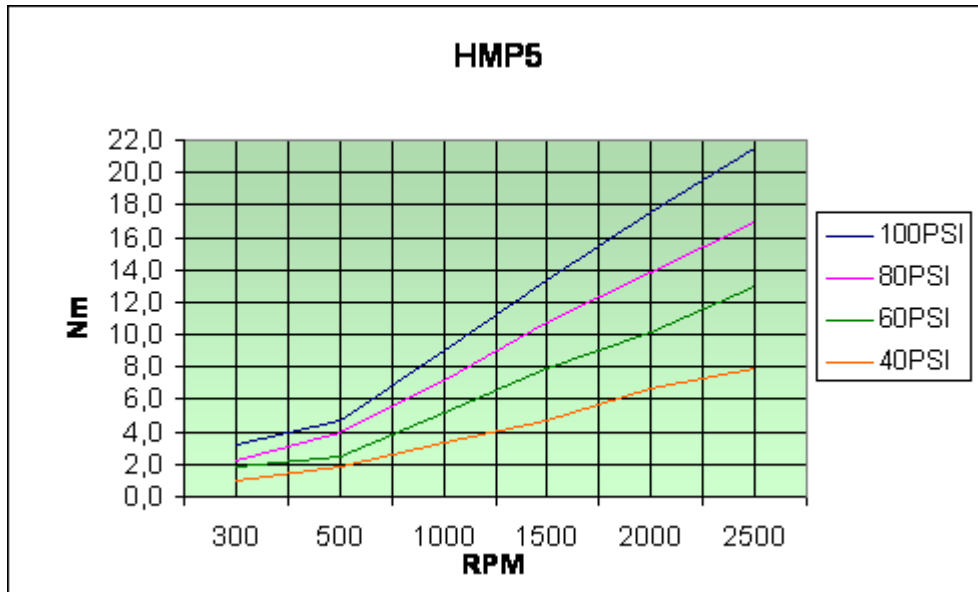

MOTOR MODELO HMP6

Rotação x Potencia

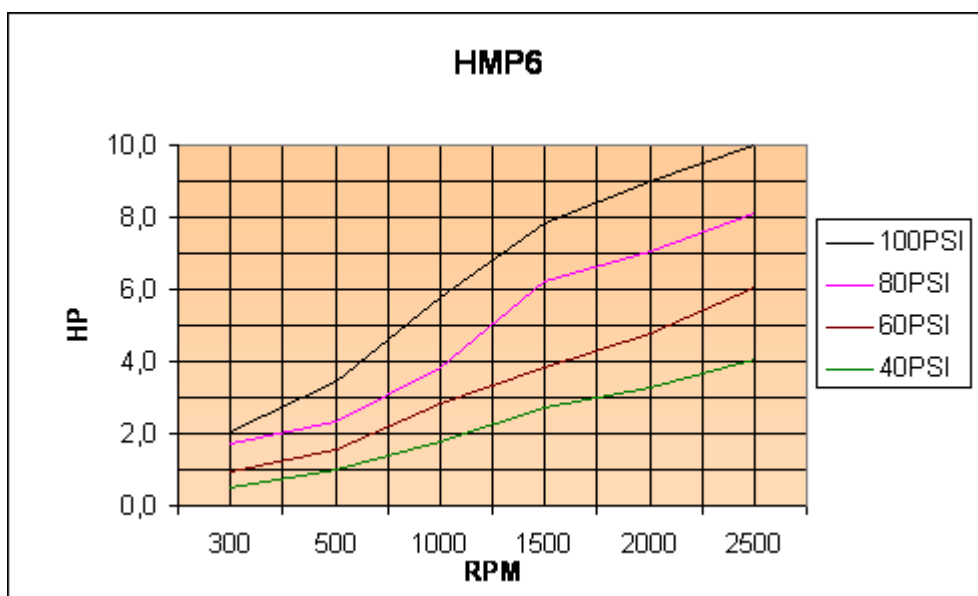



Consumo de ar do motor HMP6

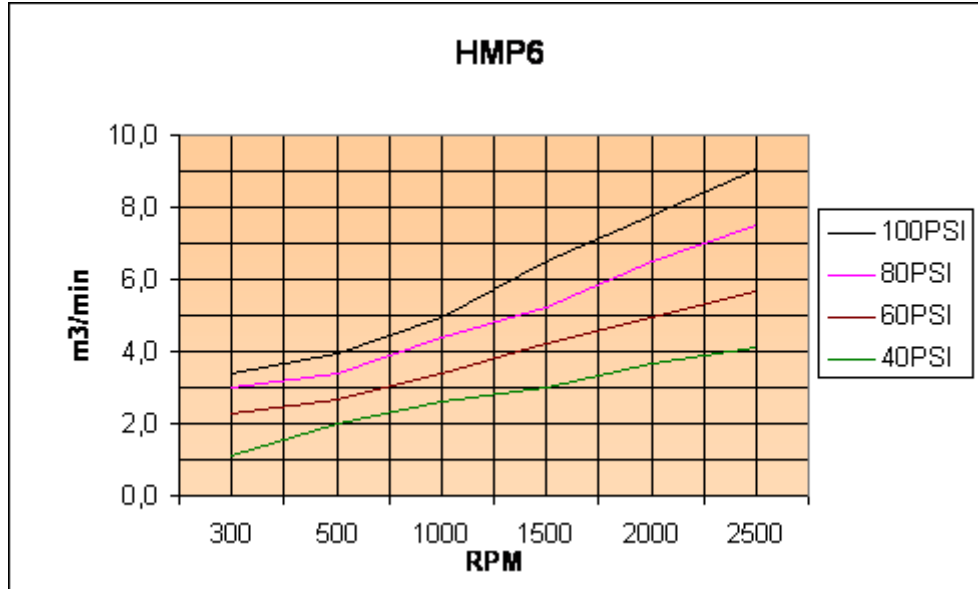

Torque do motor HMP6

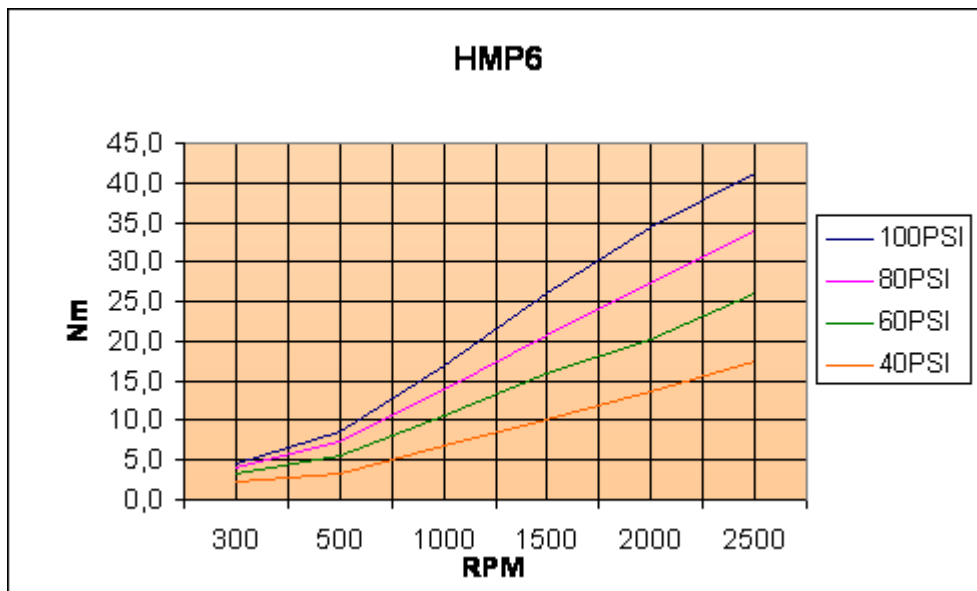



DESENHOS E DIMENSÕES

Motor com flange

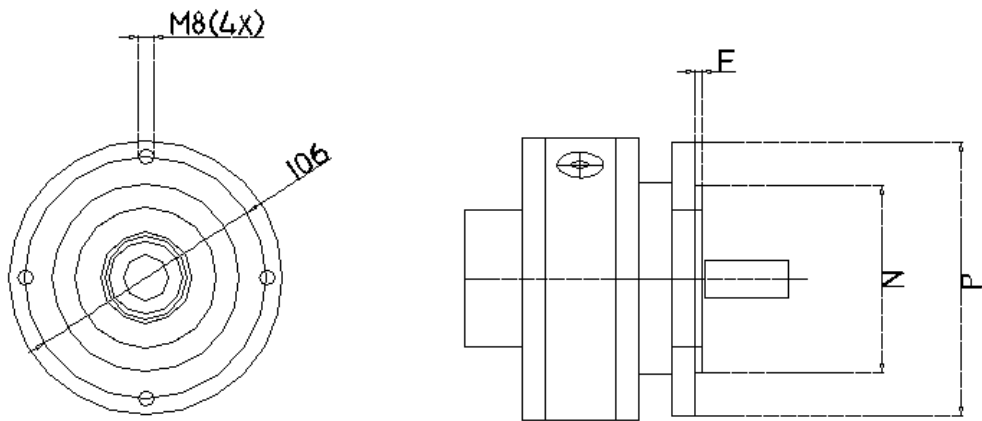

Motor com base

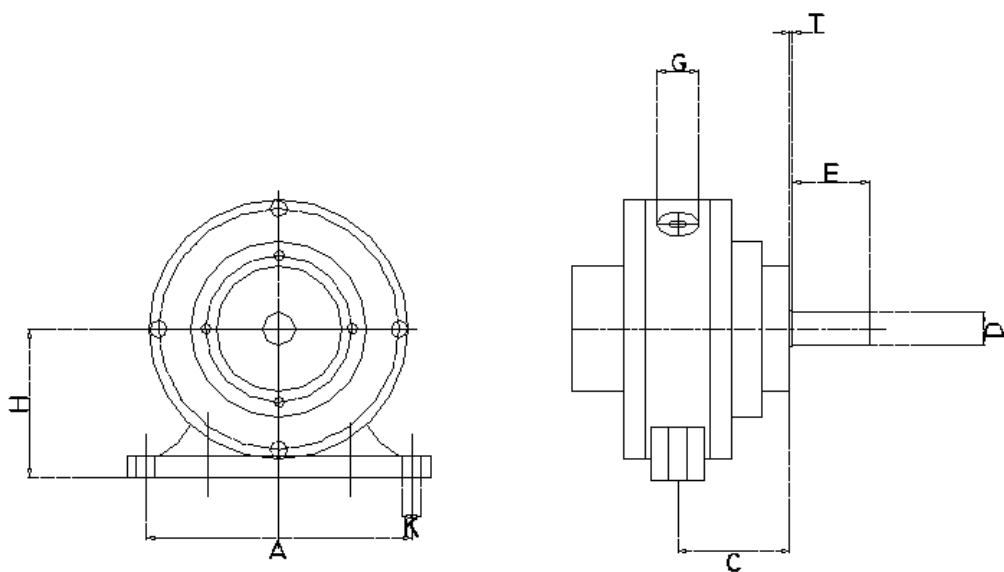



DIMENSÕES (mm)

Modelo	A	C	D	E	F	G in*	H	K	N	P	L
HMP 0	100	50	14	33	3	1/4	60	6,5	72	120	138
HMP 1	100	50	14	33	3	1/4	60	6,5	72	120	138
HMP 2	127	53.5	16	37	3	3/8	72	8,5	82	120	142
HMP 4	127	58	16	37	3	1/2	72	8,5	82	120	186
HMP 5	140	65	20	40	4	1/2	77	8,5	98	140	218
HMP 6	140	110	24	50	4	1	77	8,5	98	140	305

*NPT



HINDAG

INDUSTRIA E COMERCIO LTDA.
